

Metoder til at reducere kompleksiteten i SNOMED CT-implementering

Af Anne Randorff Højen,

E-sundhedsobservatoriets årskonference, d. 2. oktober 2014

FORVENTNINGEN TIL SNOMED CT

- Semantisk interoperabilitet
- Effektivisering og øget kvalitet af klinisk dokumentation
- Dataudtræk og analyse
- (Automatiseret) beslutningsstøtte

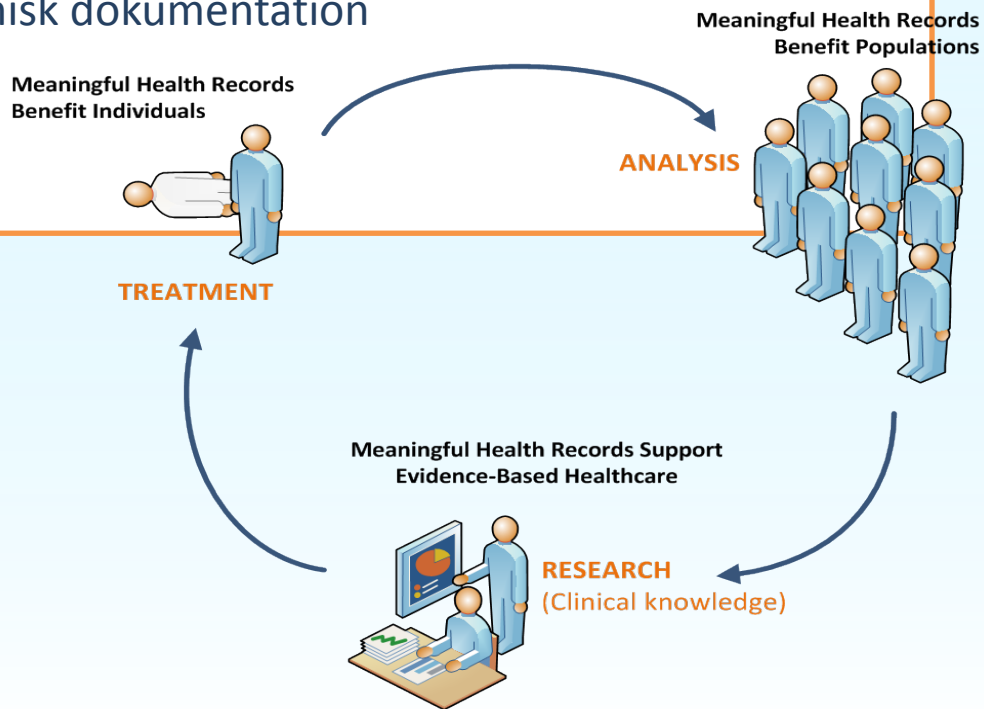

HVORFOR HAR VI BRUG FOR SØGEVÆRKTØJER?

SNOMED CT er verdens mest omfattende kliniske terminologi. Indeholder begreber, der spænder over alle de informationstyper man vil kunne registrere i kliniske IT-systemer.

Samtidig er det den terminologi man i Danmark har valgt at oversætte og anbefale.

Størrelsen og strukturen i SNOMED CT stiller krav til effektive og intuitive søgefunktionaliteter



UDFORDRINGEN VED SØGNING I SNOMED CT

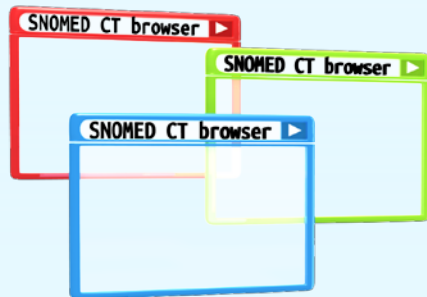

- Diabetes type
- Renal diabetes
- Labile diabetes
- Latent diabetes
- Bronze diabetes
- Diabetes clinic
- Brittle diabetes
- Bronzed diabetes
- Diabetes mellitus
- Chemical diabetes
- Diabetes resolved
- Diabetes dietitian
- Anaemia of diabetes
- Diabetes monitored
- Phosphate diabetes
- Diabetes insipidus
- Child diabetes diet
- Anaemia of diabetes
- Adult diabetes diet

KONSISTENT BEGREBUDVÆLGELSE EN UDFORDRING VED SNOMED CT IMPLEMENTERING



KONSISTENT BEGREBUDVÆLGELSE

EN UDFORDRING VED SNOMED CT IMPLEMENTERING

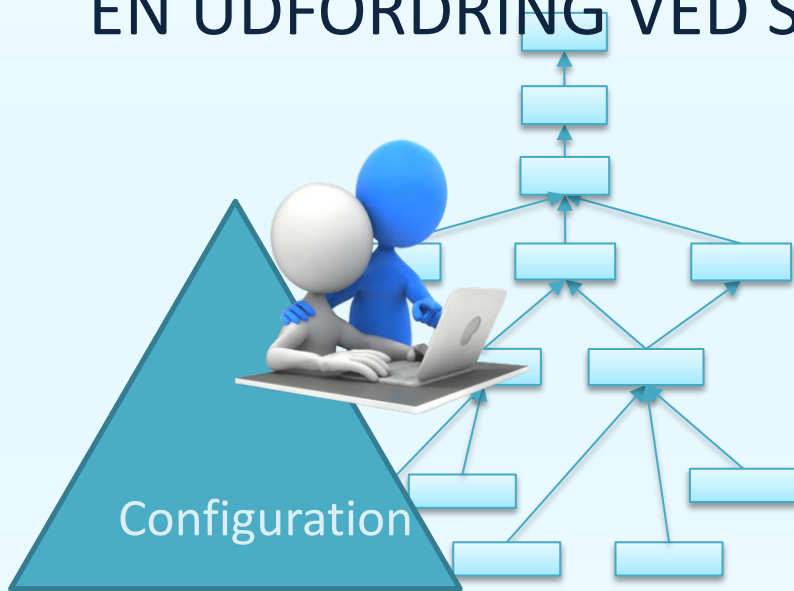

- Fokus på konsistent anvendelse af SNOMED CT.
- Begrebsudvælgelse kræver tydelige og omfattende regler.
- Nødvendigt med viden om SNOMED CT's indhold og struktur.
- Værktøjer er vigtige, såsom mere sofistikerede browsers/søgefunktionaliteter.

1. CHIANG, Michael F., et al. Reliability of SNOMED-CT coding by three physicians using two terminology browsers. In: AMIA Annual Symposium Proceedings. American Medical Informatics Association, 2006. p. 131.
2. ANDREWS, James E.; RICHESSON, Rachel L.; KRISCHER, Jeffrey. Variation of SNOMED CT coding of clinical research concepts among coding experts. Journal of the American Medical Informatics Association, 2007, 14.4: 497-506.
3. VIKSTRÖM, Anna, et al. Mapping the categories of the Swedish primary health care version of ICD-10 to SNOMED CT concepts: Rule development and intercoder reliability in a mapping trial. BMC Medical Informatics and Decision Making, 2007, 7.1: 1-9.

BAGGRUND FOR DENNE PRÆSENTATION

- Præsenterer anbefalede teknikker der kan støtte søgning i og dokumentation vha. SNOMED CT
- Udviklet som en del af 'SNOMED CT Implementation Advisor Scheme 2013'

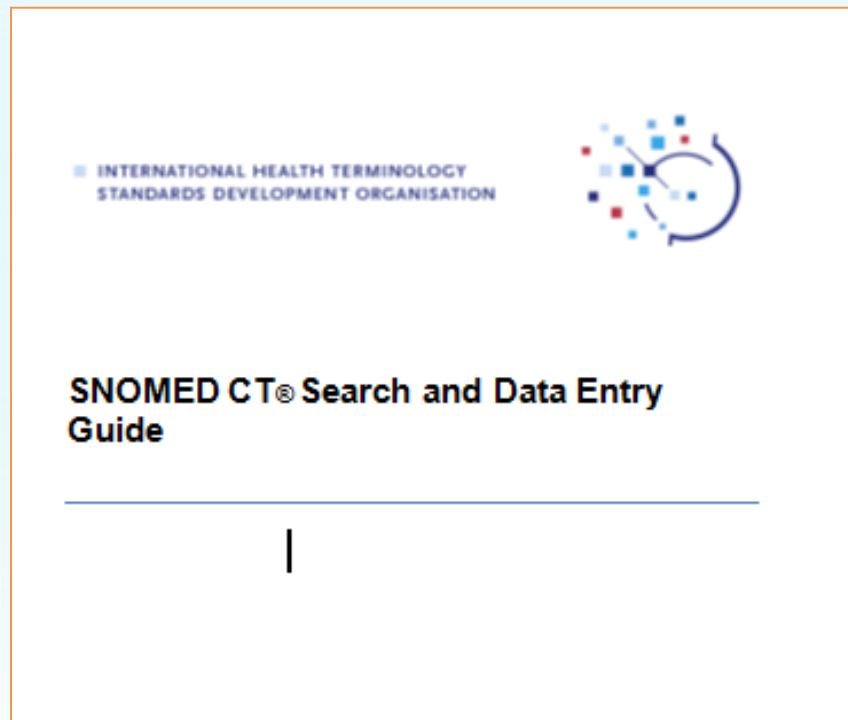

HVAD ER EN SNOMED CT SØGNING?

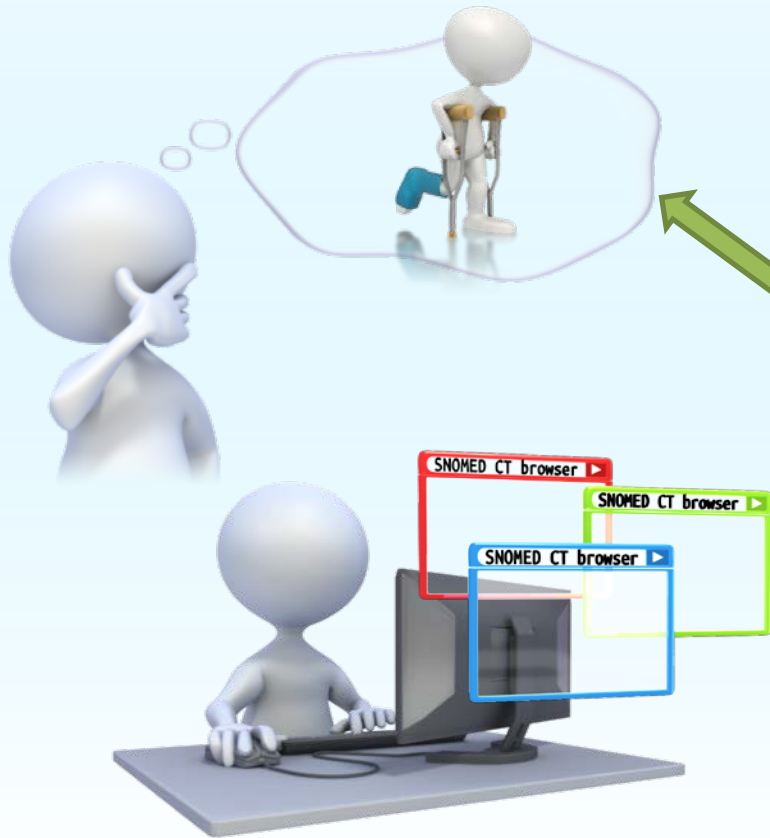

- Fracture of lower limb
- Injury of ankle
- **Fracture of ankle**
- Closed fracture of ankle
- Fracture dislocation of ankle joint
- Fracture of distal end of fibula
- Fracture of distal end of tibia
- Fracture of talus
- Open fracture of ankle

Search input

Lexical search

- Terms in any order
- Phrase match
- Identical terms

Search by identifiers

- Concept Identifiers
- Description Identifiers

Search constrains

Constrain by hierarchy

- Top-level hierarchy
- Sub-type hierarchy

Constrain by Reference Sets

- Language
- Context

Constrain by attribute relationships

- Specific defining characteristics

Search extensions

Extend using word equivalence

- Words with equivalent meaning

Display of search results

Order results rationally

- Shortest terms length
- Preferred terms
- Frequently used terms

Technical aspects

Improve search speed

- Run-time searches
- Search stop and cancellation
- Indexing

TEKNIKKER DER UNDERSTØTTER EFFEKTIV SØGNING

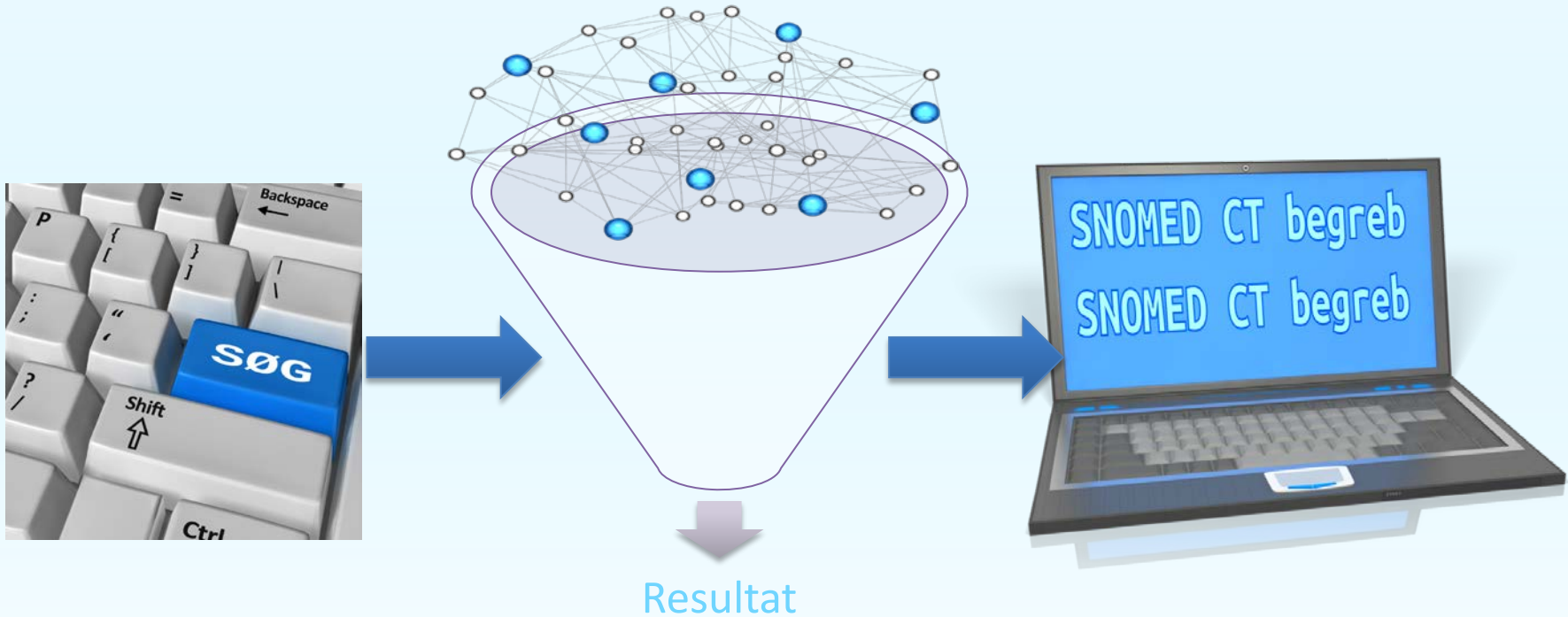

TEKNIKKER DER UNDERSTØTTER EFFEKTIV SØGNING



Hvordan håndteres input?

- Standard søgeteknikker:
 - Termer og identifiers
 - Rækkefølge af termer
 - Identiske termer
 - Osv.

SNOMED CT PÅ DANSK

- Søgning vha. termer
 - Guiden henvender sig til alle IHTSDO-medlemslande
 - Teknikkerne er overførbare til en dansk kontekst
 - I Danmark er der 'kun' oversat én term pr. begreb
 - Kombiner søgning og visning af danske og engelske termer.



SØGNING VHA. IDENTIFIERS

COLD (CONCEPT ID:13645005)

F	★	Chronic obstructive lung disease (disorder)	Preferred
S	✓	CAFL - Chronic airflow limitation	Acceptable
S	✓	CAL - Chronic airflow limitation	Acceptable
S	✓	CAO - Chronic airflow obstruction	Acceptable
S	✓	COAD - Chronic obstructive airways disease	Acceptable
S	✓	COLD	Acceptable
S	✓	COLD - Chronic obstructive lung disease	Acceptable
S	✓	COPD	Acceptable
S	✓	COPD - Chronic obstructive pulmonary disease	Acceptable
S	✓	Chronic airflow limitation	Acceptable
S	✓	Chronic airflow obstruction	Acceptable
S	✓	Chronic airway disease	Acceptable
S	✓	Chronic airway obstruction	Acceptable
S	✓	Chronic irreversible airway obstruction	Acceptable
S	✓	Chronic obstructive airway disease	Acceptable
S	★	Chronic obstructive lung disease	Preferred
S	✓	Chronic obstructive pulmonary disease	Acceptable

ConceptId:
13645005



BEGRÆNSE SØGEMRÅDET

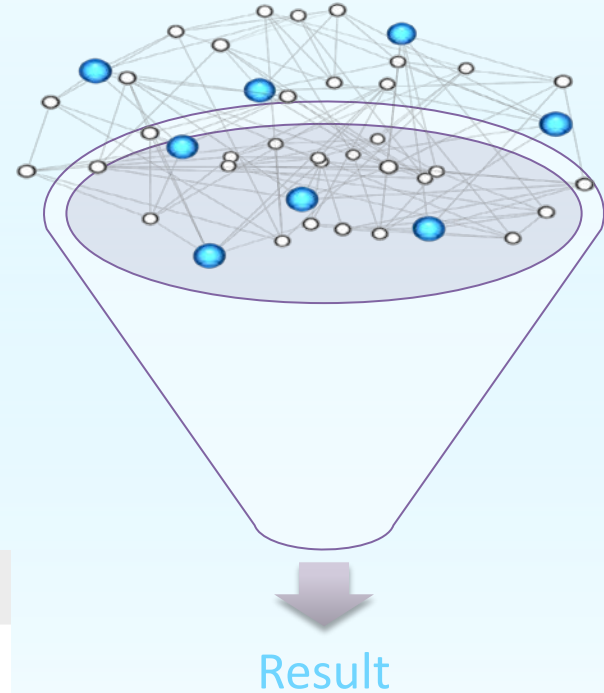

Search constrains

Constrain by hierarchy

- Top-level hierarchy
- Sub-type hierarchy

Constrain by Reference Sets

- Language
- Context

Constrain by attribute relationships

- Specific defining characteristics

BEGRÆNSE SØGEOMRÅDET – vha. hierarki

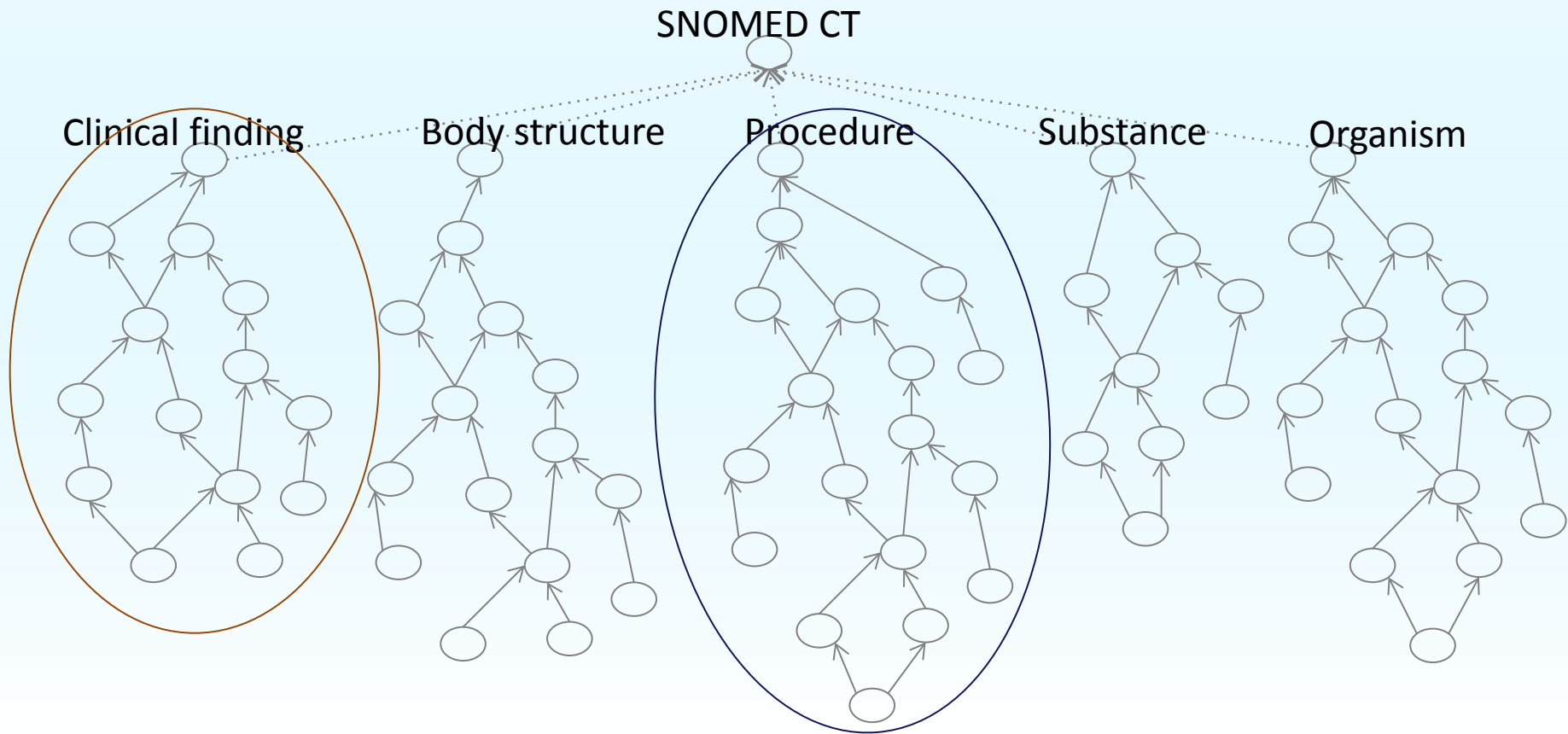

BEGRÆNSE SØGEOMRÅDET – vha. hierarki

Type at least 3 characters ✓ Example: *shou fra*

blood pressure|

337 matches found in 0.421 seconds.

● Blood pressure	Blood pressure (observable entity)
● Low blood pressure	Low blood pressure (disorder)
● Cuff blood pressure	Non-invasive arterial pressure measurement (observable entity)

Filter results by Semantic Tag

observable entity	127
finding	86
procedure	61
regime/therapy	21
disorder	16
situation	11
physical object	6
assessment scale	5
qualifier value	4

BEGRÆNSE SØGEOMRÅDET – vha. sub-hierarki

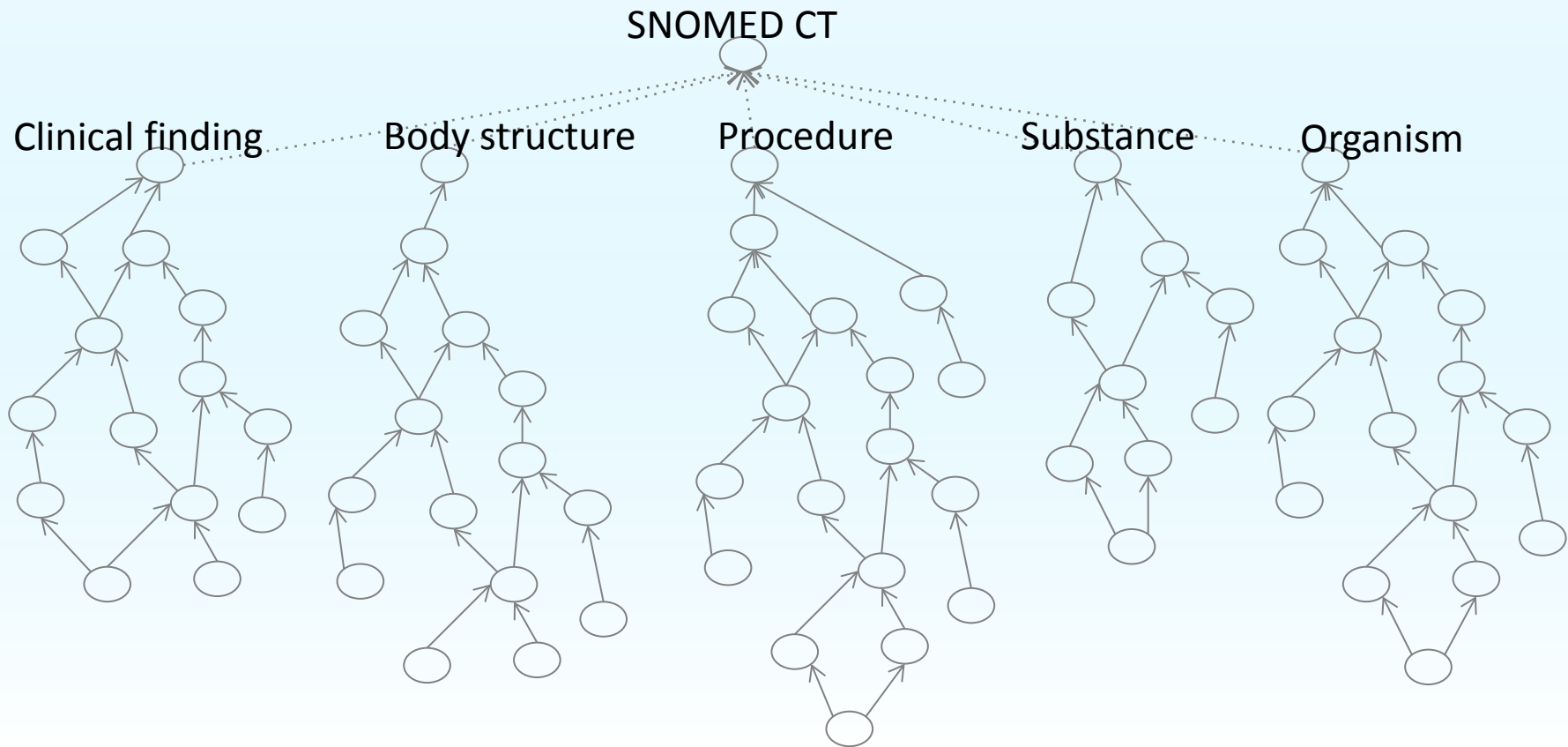

HVIS MAN IKKE ER OPMÆRKSOM PÅ HIERARKIERNE

Forslag 1:

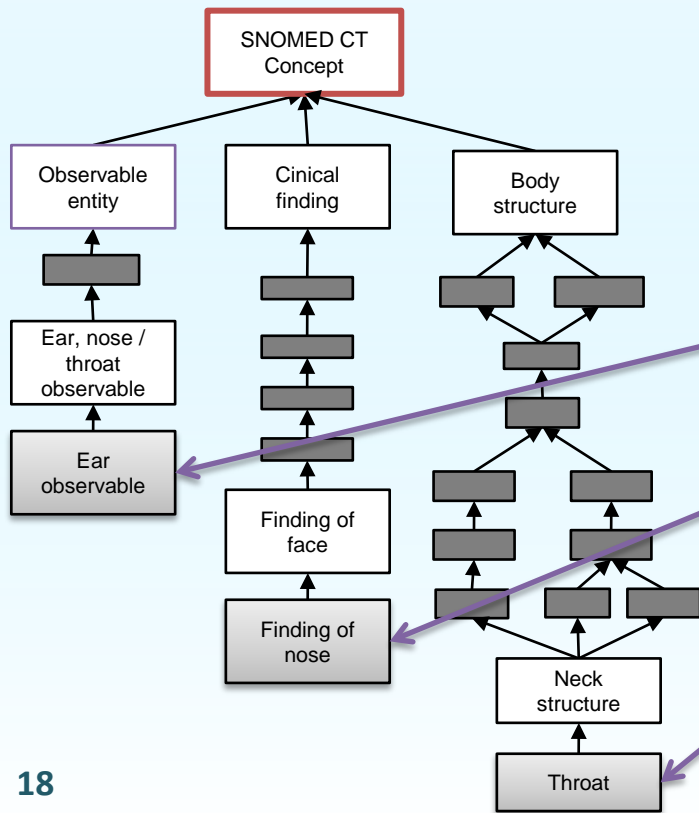

Skabelon:

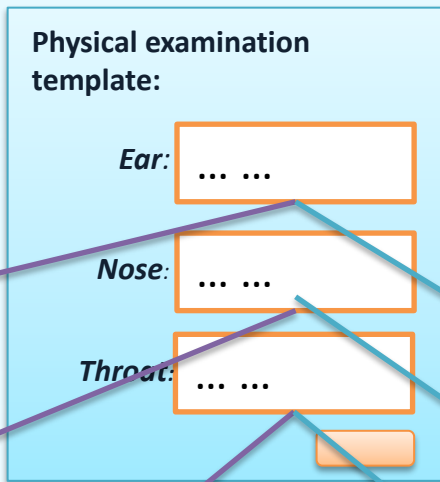

Forslag 2:

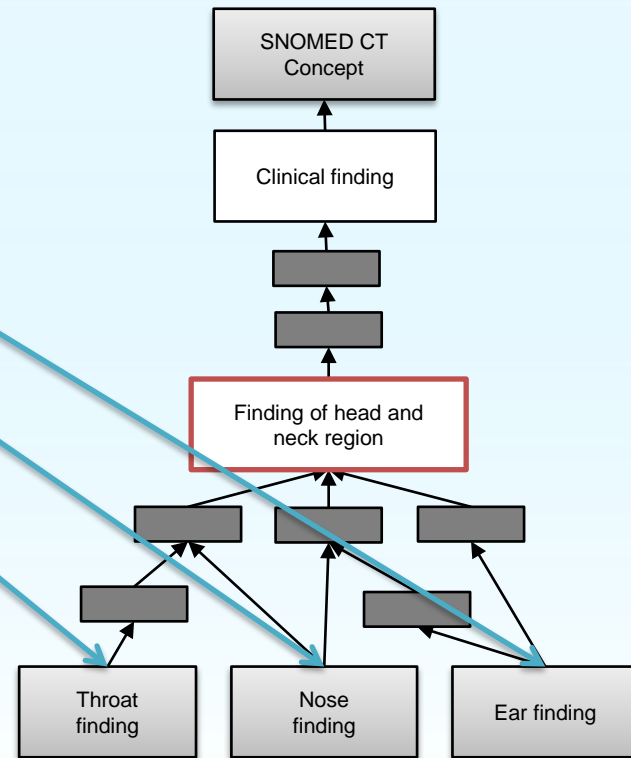

BEGRÆNS VHA. RELATIONER

- Constraints based on particular attributes of the concept
 - For example, only concepts with the attribute |associated morphology| having the value |inflammation|.

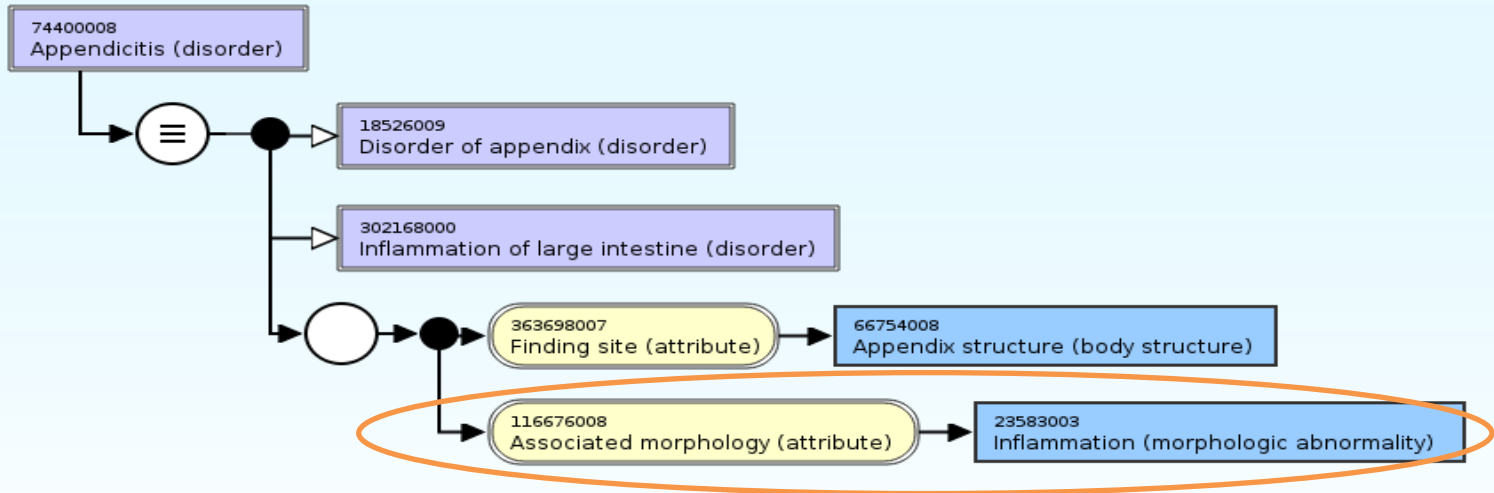

BEGRÆNS VHA. RELATIONER

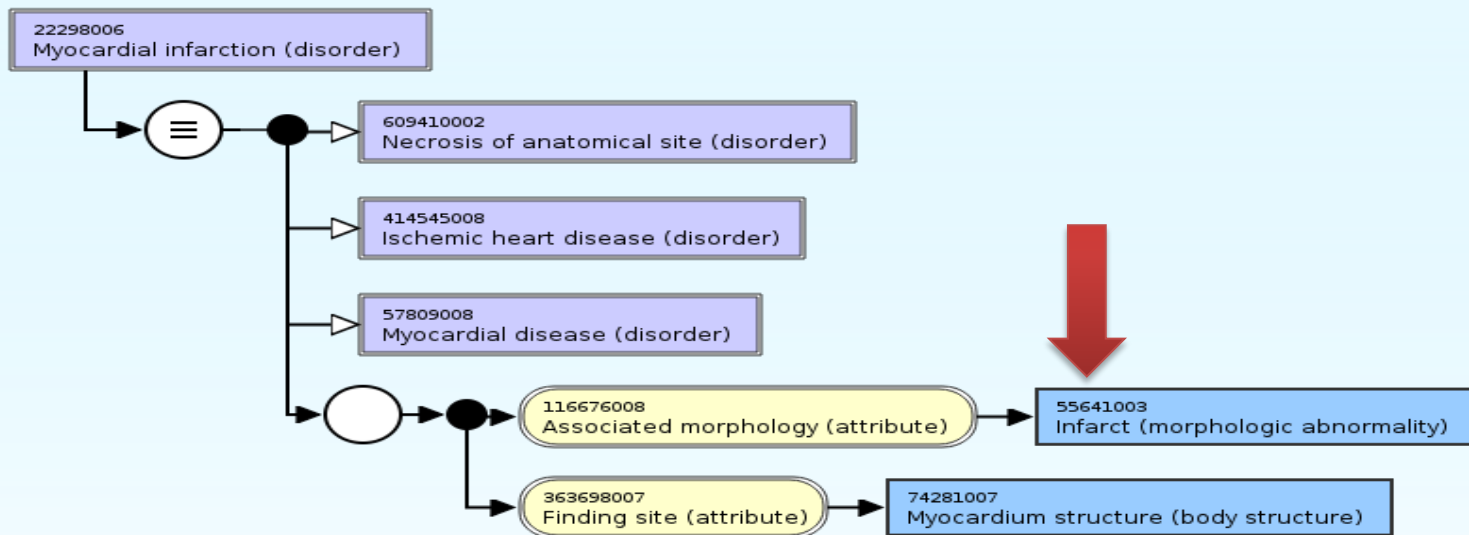

Search input

Lexical search

- Terms in any order
- Phrase match
- Identical terms

Search by identifiers

- Concept Identifiers
- Description Identifiers

Search constrains

Constrain by hierarchy

- Top-level hierarchy
- Sub-type hierarchy

Constrain by Reference Sets

- Language
- Context

Constrain by attribute relationships

- Specific defining characteristics

Search extensions

Extend using word equivalence

- Words with equivalent meaning

Display of search results

Order results rationally

- Shortest terms length
- Preferred terms
- Frequently used terms

Technical aspects

Improve search speed

- Run-time searches
- Search stop and cancellation
- Indexing

OPMÆRKSOMHED PÅ BEGREBER – i stedet for termer

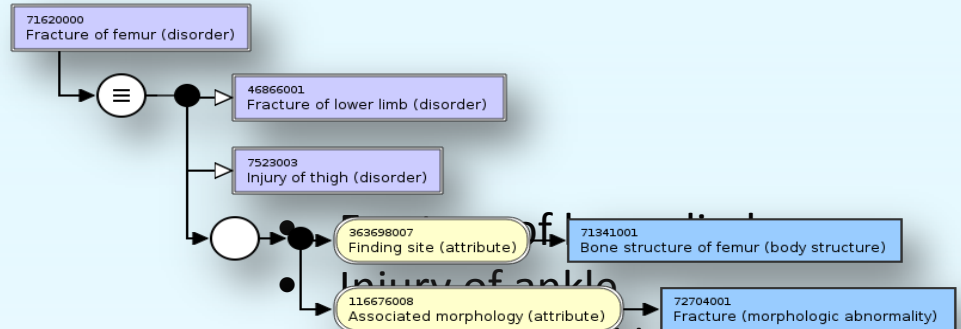
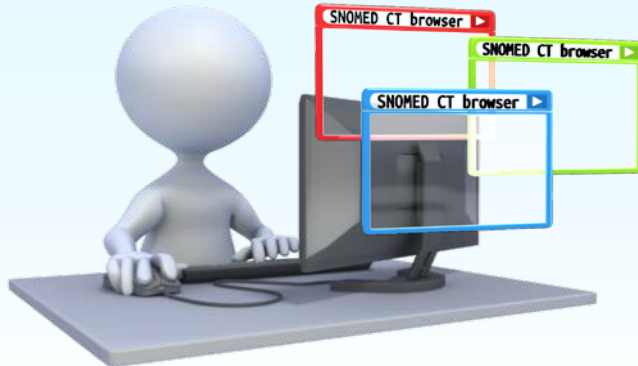

- Injury of ankle
- Fracture of ankle
- Closed fracture of ankle
- Fracture dislocation of ankle joint
- Fracture of distal end of fibula
- Fracture of distal end of tibia
- Fracture of talus
- Open fracture of ankle

KOMPLEKSITETSFÆLDE??

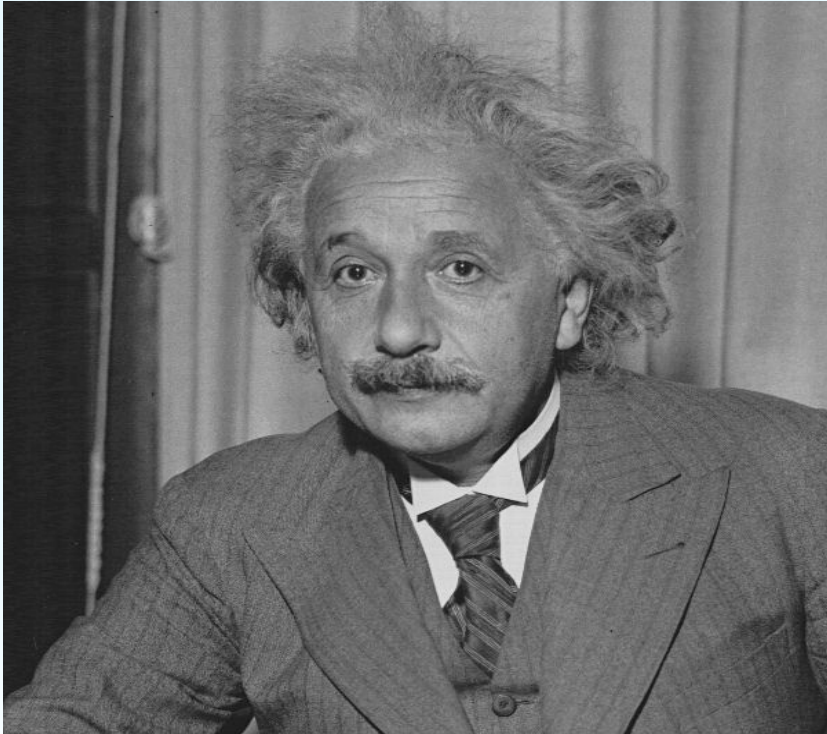

**‘Everything should be
made as simple as
possible,
but no simpler.’**

Albert Einstein

[slide from David Markwell,

FOR AT KUNNE DETTE.....



[slide from David Markwell,

... SKAL MAN FORSTÅ DETTE....

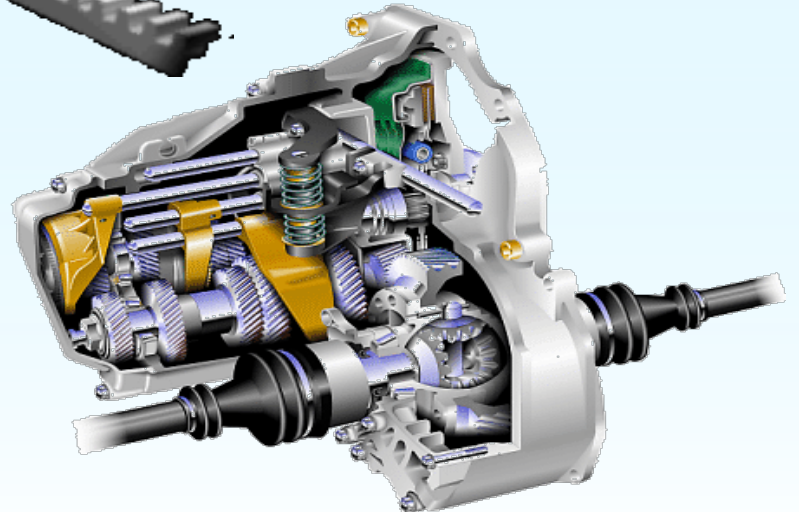
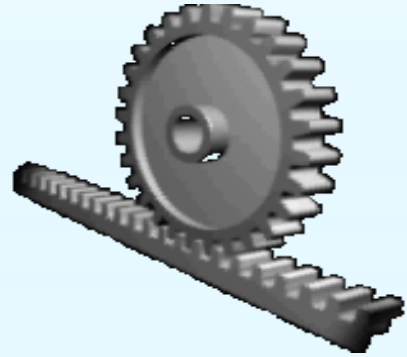

[slide from David Markwell,

... ELLER BARE DETTE....



[slide from David Markwell,

Thank you

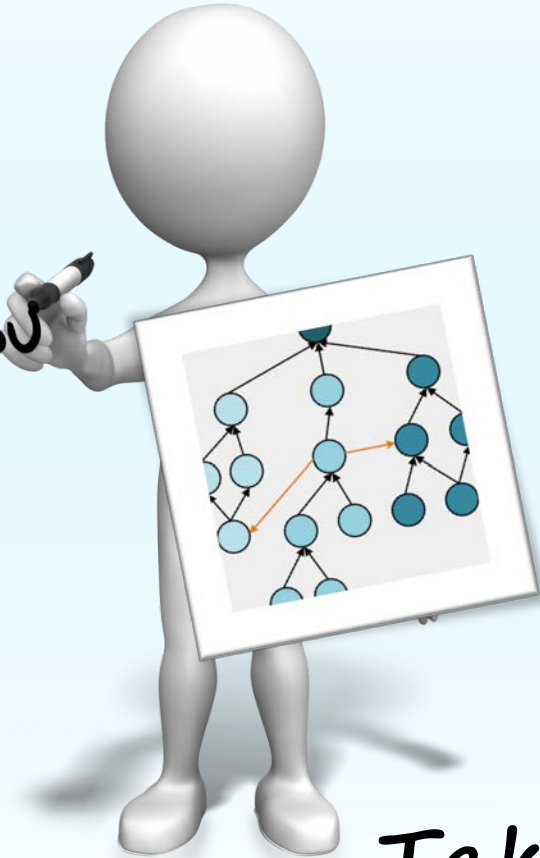

REFERENCER:

- SNOMED CT Document Library:
(www.snomed.org/doc).
- SNOMED CT E-learning Center:
<http://snomed.org/elearning>
- PHD-afhandling af Anne Højen:
<http://person.hst.aau.dk/arra/pages/PhD/dissertation.pdf>

Kontakt: arra@hst.aau.dk

... Tak for
opmærksomheden